

# JVC

**COMPACT VHS CAMCORDER**

**GR-AXM18U**

INSTRUCTIONS

ENGLISH

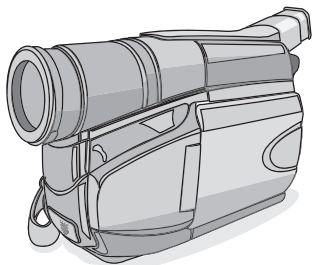

**For Customer Use:**

Enter below the Model No. and Serial No. which is located on the bottom of the camcorder. Retain this information for future reference.

**Model No.** \_\_\_\_\_

**Serial No.** \_\_\_\_\_

## CONTENTS

<b>GETTING STARTED</b>	5 ~ 9
<b>RECORDING/PLAYBACK</b>	9 ~ 10
<b>BASIC FEATURES</b>	10 ~ 12
<b>MENU SETTINGS</b>	12 ~ 15
<b>REFERENCES</b>	16 ~ 18

**VHS**

**Compact VHS**

### AUTOMATIC DEMONSTRATION

**Automatic Demonstration takes place when "DEMO MODE" is set to "ON" (factory-preset).**

- Available when the Power Switch is set to "A" or "M".
- To cancel Automatic Demonstration, set "DEMO MODE" to "OFF" (☞ pg. 15).

### Dear Customer,

Thank you for purchasing the JVC Compact VHS camcorder. Before use, please read "SAFETY PRECAUTIONS" (☞ pg. 3, 4) to ensure safe use of this product.

LYT1519-001A

## PROVIDED ACCESSORIES

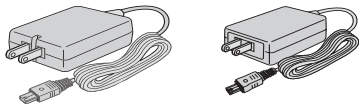

AC Adapter AP-V14U or  
AP-V18U



Battery Pack  
BN-V10U

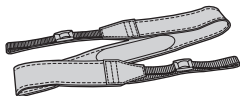

Shoulder Strap

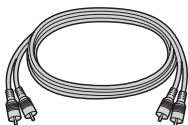

A/V (Audio/Video)  
Cable



Lens Cap

## OPTIONAL ACCESSORIES

- Battery Packs BN-V12U, BN-V20U, BN-V400U
- Compact VHS (VHS) Cassettes TC-40/30/20
- Active Carrying Bag CB-V75
- Cassette Adapter C-P8U

Some accessories are not available in some areas.

Please consult your nearest JVC dealer for details on accessories and their availability.

### NOTE:

In order to maintain optimum performance of the camcorder, provided cables may be equipped with one or more core filter. If a cable has only one core filter, the end that is closest to the filter should be connected to the camcorder.

## SAFETY PRECAUTIONS



The lightning flash with arrowhead symbol, within an equilateral triangle, is intended to alert the user to the presence of uninsulated "dangerous voltage" within the product's enclosure that may be of sufficient magnitude to constitute a risk of electric shock to persons.



The exclamation point within an equilateral triangle is intended to alert the user to the presence of important operating and maintenance (servicing) instructions in the literature accompanying the appliance.

### WARNING:

**TO REDUCE THE RISK OF FIRE OR ELECTRIC SHOCK, DO NOT EXPOSE THIS APPARATUS TO RAIN OR MOISTURE.**

## CAUTIONS

- This camcorder is designed to be used with NTSC-type color television signals. It cannot be used for playback with a television of a different standard. However, live recording and LCD monitor/viewfinder playback are possible anywhere.
- Use the JVC BN-V10U/V12U/V20U/V400U battery packs and, to recharge them or to supply power to the camcorder from an AC outlet, use the provided multi-voltage AC Adapter.  
(An appropriate conversion adapter may be necessary to accommodate different designs of AC outlets in different countries.)

### NOTES:

- The rating plate (serial number plate) and safety caution are on the bottom and/or the back of the main unit.
- The rating information and safety caution of the AC Adapter are on its upper and lower sides.

## ATTENTION

The product that you have purchased is powered by a rechargeable battery. The battery is recyclable. At the end of its useful life, under various state and local laws, it may be illegal to dispose of this battery into the municipal waste stream. Check with your local solid waste officials for details in your area for recycling options or proper disposal.



Only cassettes marked **VHS** can be used with this camcorder.

The EPA certified RBRC® Battery Recycling Seal on the nickel-cadmium (Ni-Cd) battery indicates JVC is voluntarily participating in an industry program to collect and recycle these batteries at the end of their useful life, when taken out of service in the United States. The RBRC® program provides a convenient alternative to placing used Ni-Cd batteries into the trash or the municipal waste stream, which may be illegal in your area. Please call 1-800-8-BATTERY™ for information on Ni-Cd battery recycling and disposal bans/restrictions in your area. JVC's involvement in this program is part of our commitment to preserving our environment and conserving our natural resources.

When the equipment is installed in a cabinet or on a shelf, make sure that it has sufficient space on all sides to allow for ventilation (10 cm (3-15/16") or more on both sides, on top and at the rear).

Do not block the ventilation holes.

(If the ventilation holes are blocked by a newspaper, or cloth etc. the heat may not be able to get out.)

No naked flame sources, such as lighted candles, should be placed on the apparatus.

When discarding batteries, environmental problems must be considered and the local rules or laws governing the disposal of these batteries must be followed strictly.

The apparatus shall not be exposed to dripping or splashing.

Do not use this equipment in a bathroom or places with water.

Also do not place any containers filled with water or liquids (such as cosmetics or medicines, flower vases, potted plants, cups etc.) on top of this unit.

(If water or liquid is allowed to enter this equipment, fire or electric shock may be caused.)

## IMPORTANT SAFETY INSTRUCTIONS

- 1) Read these instructions.
- 2) Keep these instructions.
- 3) Heed all warnings.
- 4) Follow all instructions.
- 5) Do not use this apparatus near water.
- 6) Clean only with dry cloth.
- 7) Do not block any ventilation openings. Install in accordance with the manufacturer's instructions.
- 8) Do not install near any heat sources such as radiators, heat registers, stoves, or other apparatus (including amplifiers) that produce heat.
- 9) Only use attachments/accessories specified by the manufacturer.
- 10) Use only with the cart, stand, tripod, bracket, or table specified by the manufacturer, or sold with the apparatus. When a cart is used, use caution when moving the cart/apparatus combination to avoid injury from tip-over.
- 11) Unplug this apparatus during lightning storms or when unused for long periods of time.
- 12) Refer all servicing to qualified service personnel. Servicing is required when the apparatus has been damaged in any way, such as power-supply cord or plug is damaged, liquid has been spilled or objects have fallen into the apparatus, the apparatus has been exposed to rain or moisture, does not operate normally, or has been dropped.



# CONTROLS, CONNECTORS AND INDICATORS

Refer to this diagram while reading the instructions.

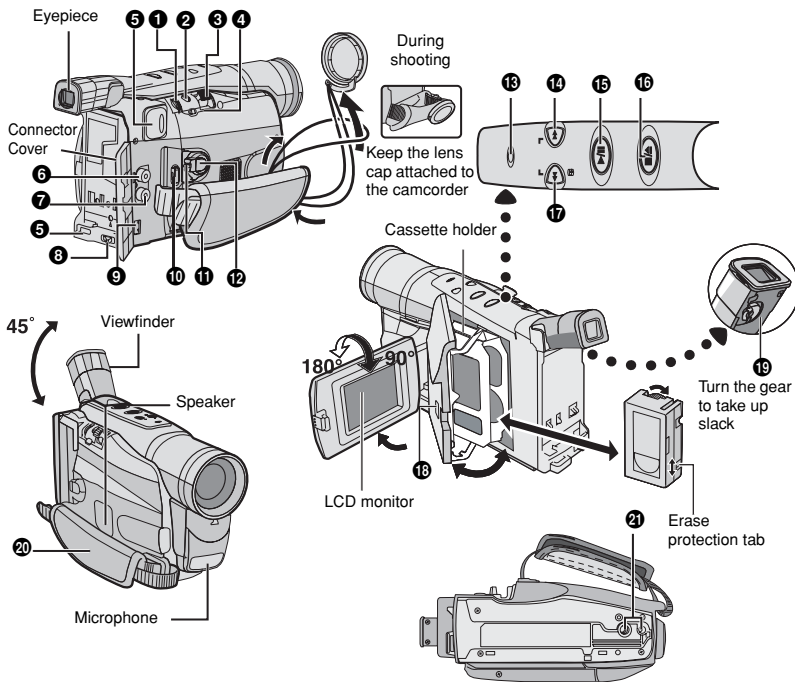

## LCD Monitor/Viewfinder Indications

During Recording

During Playback

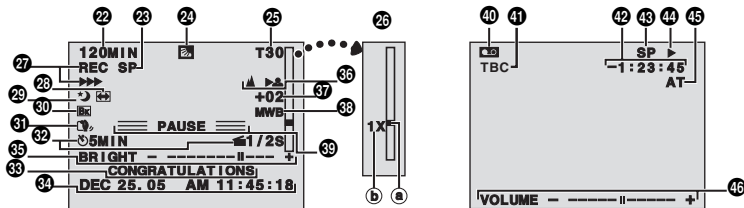

pg. 16 for "Warning Indications"

- 1 • MENU Wheel [-, +]..... 7 pg. 8
  - BRIGHT Wheel [-, +]..... 7 pg. 14
  - Speaker Volume Control [VOL.]..... 7 pg. 10
  - TRACKING Wheel [-, +]..... 7 pg. 11
- 2 5- Second Recording Button  
[5 SEC. REC]..... 7 pg. 10
- 3 Power Zoom Lever [T/W]..... 7 pg. 10
- 4 • Manual Focus Button [M] FOCUS]..... 7 pg. 10
  - Time Base Corrector Button [TBC]..... 7 pg. 11
- 5 Shoulder Strap Eyelets..... 7 pg. 9
- 6 Audio Output Connector [A]..... 7 pg. 11
- 7 Video Output Connector [V]..... 7 pg. 11
- 8 Battery Release Switch  
[BATTERY RELEASE]..... 7 pg. 7
- 9 DC IN Connector..... 7 pg. 7
- 10 • Recording Start/Stop Button..... 7 pg. 9
  - REFRESH Button..... 7 pg. 7
- 11 Lock Button..... 7 pg. 8
- 12 Power Switch [PLAY, OFF, A , M].... 7 pg. 7, 8, 9
- 13 POWER/CHARGE Lamp..... 7 pg. 7
- 14 • Retake Forward Button [RETAKE F] .. 7 pg. 10
  - Fast-Forward Button [F]..... 7 pg. 9
- 15 • Play/ Pause Button..... 7 pg. 9
  - Backlight Compensation Button ..... 7 pg. 10
- 16 • Stop Button [STOP]..... 7 pg. 9
  - Eject [EJECT] Button ..... 7 pg. 9
- 17 • Retake Rewind Button [RETAKE R] ... 7 pg. 10
  - Quick Review Button [C R]..... 7 pg. 10
  - Rewind Button [R] ..... 7 pg. 9
- 18 Close Button..... 7 pg. 9
- 19 Diopter Adjustment Control..... 7 pg. 8
- 20 Grip Strap..... 7 pg. 8
- 21 Tripod Mounting Socket..... 7 pg. 9
- 22 Tape Remaining Time..... 7 pg. 14
- 23 Recording Mode Indicator..... 7 pg. 13
- 24 Backlight Compensation Indicator ..... 7 pg. 10
- 25 Tape Length Indicator..... 7 pg. 14
- 26 Zoom Indicator Bar..... 7 pg. 10
  - a Zoom Level Indicator
  - b Approximate Zoom Ratio
- 27 Recording Indicator..... 7 pg. 9
- 28 Digital Effect Indicator..... 7 pg. 13
- 29 Program AE Indicator..... 7 pg. 13
- 30 Fade/Wipe-Standby Indicator..... 7 pg. 13
- 31 Picture Stabilizer Indicator..... 7 pg. 14
- 32 • Interval Time/Recording Time Indicator..... 7 pg. 15
  - 5 Sec. Rec Mode Indicator..... 7 pg. 10
- 33 Instant Title Display..... 7 pg. 14
- 34 Date/Time Display..... 7 pg. 15
- 35 Bright Level Indicator..... 7 pg. 14
- 36 Focus Indicator..... 7 pg. 10
- 37 Exposure Control Level Counter..... 7 pg. 13
- 38 White Balance Mode Indicator..... 7 pg. 14
- 39 Record-Standby Mode Indicator..... 7 pg. 9
- 40  : Cassette Indicator..... 7 pg. 16
- 41 TBC Indicator..... 7 pg. 11
- 42 Tape Counter..... 7 pg. 15
- 43 Recording Mode Indicator (SP/EP)..... 7 pg. 13
- 44 Tape Running Indicator
  - ▶ : Playback
  - ▶▶ : Fast-Forward/ Shuttle Search
  - ◀◀ : Rewind/ Shuttle Search
  - ||: Pause
- 45 Tracking Indicator..... 7 pg. 11
- 46 VOLUME: Speaker Volume Indicator..... 7 pg. 10

## GETTING STARTED

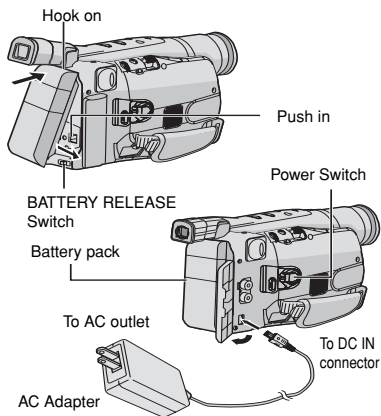

### Charging the Battery Pack

- 1) Hook the end of the battery pack to the camcorder and push the battery in until it locks in place.
  - If the battery pack is attached wrongly, a malfunction may occur.
- 2) Set the Power Switch **12** to "OFF" while pressing down the Lock Button **11**. Connect the AC Adapter to the DC IN connector **9**, then plug the AC Adapter to the AC Outlet.
- 3) The CHARGE lamp **13** blinks to indicate charging.
- 4) When the CHARGE lamp **13** stops blinking and turns off, charging is finished. Unplug the AC Adapter from the AC outlet. Disconnect the AC Adapter from the camcorder.

### To Detach The Battery Pack...

... slide BATTERY RELEASE **8** and pull out the battery pack.

Battery Pack	Charging time
BN-V10U	approx. 1 hr. 30 min.
BN-V12U (optional)	approx. 1 hr. 40 min.
BN-V20U (optional)	approx. 2 hrs. 40 min.
BN-V400U (optional)	approx. 5 hrs. 10 min.

Charging time is for a fully discharged battery pack.

### Using the Battery Pack

Perform step 1) of "Charging the Battery Pack".  
**Approximate recording time (unit: min.)**

Battery Pack	Viewfinder on	LCD monitor on
BN-V10U	100	80
BN-V12U (optional)	105	85
BN-V20U (optional)	170	140
BN-V400U (optional)	400	330

### Using AC Power

Connect the AC Adapter to the camcorder (step 2) of "Charging the Battery Pack").

- The provided AC Adapter features automatic voltage selection in the AC range from 110V to 240V.

### ATTENTION:

Before detaching the power source, make sure that the camcorder's power is turned off. Failure to do so can cause the camcorder to malfunction.

### REFRESH:

Be sure to fully discharge a battery pack before recharging or storing it for a long period of time, otherwise the battery performance will be reduced.

- 1) Perform steps 1) through 3) of "Charging the Battery Pack".
- 2) Press REFRESH **10** for over 4 seconds. The CHARGE lamp **13** blinks faster to indicate discharging.
- 3) When discharging is finished, charging automatically starts and the CHARGE lamp **13** blinks normally.

**STORE BATTERY:**

Be sure to fully discharge a battery pack by performing the following steps before storing it for a long period of time, otherwise the battery performance will be reduced.

- 1) Attach the battery to the camcorder with no cassette inserted.
- 2) Set the Power Switch **12** to "A" or "M" while pressing down the Lock Button **11**.
  - During charging or discharging, the camcorder cannot be operated.
  - Charging and discharging are not possible if the wrong type of battery is used.
  - When charging the battery pack for the first time or after a long storage period, the CHARGE lamp **18** may not light. Remove the battery pack from the camcorder, then try charging again.
  - If a fully-charged battery's operation time remains extremely short, the battery is worn out. Please purchase a new one.
  - Perform charging where the temperature is between 10°C and 35°C (50°F and 95°F). 20°C to 25°C (68°F to 77°F) is the ideal temperature range. If the environment is too cold, charging may be incomplete.
  - Charging time varies according to the ambient temperature and the status of the battery pack.
  - Since the AC Adapter processes electricity internally, it becomes warm during use. Be sure to use it only in well-ventilated areas.
  - The following operation stops charging or discharging:
    - Set the Power Switch **12** to "PLAY", "A" or "M".
    - Disconnect AC Adapter from the AC outlet.
    - Detach the battery from the camcorder.
- 3) Using the optional AA-V15 AC Power Adapter/Charger, you can charge the BN-V10U/V12U/V20U/V400U battery pack without the camcorder. However, it cannot be used as an AC adapter.
- 4) To avoid interference with reception, do not use the AC Adapter near a radio.
- 5) Recording time is reduced significantly when Zoom or Record-Standby mode is engaged repeatedly or the LCD monitor is used repeatedly.
- 6) Before extended use, it is recommended that you prepare enough battery packs to cover 3 times the planned shooting time.

**Date/Time Settings**

- 1) Set the Power Switch **12** to "M" while pressing down the Lock Button **11**.
- 2) Press the MENU Wheel **1** in. The TOP MENU Screen appears.
- 3) Rotate the MENU Wheel **1** to select "►TO SYSTEM MENU" and press it.
- 4) Rotate the MENU Wheel **1** to select "►DATE/TIME SET" and press it. The DATE/TIME SET Menu appears.
- 5) To set "YEAR", "MONTH", "DAY" or "TIME" (hour/minute), rotate the MENU Wheel **1** to select the desired item, and press it. When the setting begins blinking, rotate the MENU Wheel **1** until the correct setting appears and then press it. The setting stops blinking.
- 6) When none of these settings ("YEAR", "MONTH", "DAY", "TIME") blinks, rotate the MENU Wheel **1** to select "►RETURN" and press it, to go to Menu Screen.

- 7) Press the MENU Wheel **1** in to select "►EXIT" to close the Menu Screen.
  - To display the date and time in the camcorder's display and on a connected TV, see DATE/TIME DISP. (pg. 15) in SYSTEM MENU 1.
  - The date/time cannot be stored in memory if the built-in clock battery runs out. Consult an authorised JVC dealer for replacement, or set the date/time as necessary before you start shooting.

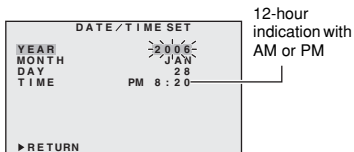
**Grip Adjustment**

- 1) Separate the Velcro strip.
- 2) Pass your right hand through the loop and grasp the grip.
- 3) Adjust so that your thumb and fingers can easily operate the Recording Start/Stop Button **10** and Power Zoom Lever **3**. Refasten the Velcro strip.

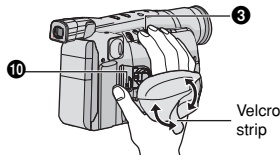
**Viewfinder Adjustment**

- 1) Set the Power Switch **12** to "A" or "M" while pressing down the Lock Button **11**.
- 2) Make sure the LCD monitor is closed and locked. Pull up the viewfinder and adjust it manually to get the best view.
- 3) Turn the Diopter Adjustment Control **19** until the indications in the viewfinder are clearly focused.

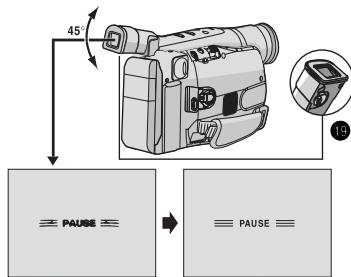



## Shoulder Strap Attachment

Thread the strap through the eyelet **5**, then fold it back and thread it through the buckle. Repeat the procedure to attach the other end of the strap to the other eyelet **5**, making sure the strap is not twisted. Adjust the length.

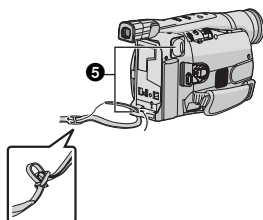

## Tripod Mounting

Align the screw and camera direction stud on the tripod with the tripod mounting socket **21**. Then tighten the screw.

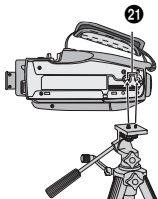

## CAUTION:

When using a tripod, be sure to extend its legs fully to stabilize the camcorder. To prevent damage to the unit caused by falling over, do not use a small tripod.

## Loading/Unloading A Cassette

- 1) Open the LCD monitor fully and keep it aligned vertically with the camera (do not tilt it). Press EJECT **16** for more than 2 seconds until the cassette holder opens. Do not force open.
  - 2) When inserting a cassette, make sure the label is facing outward.
  - 3) Press the Close button **16** to close the cassette holder until it locks in place. Close the LCD monitor.
- Closing the LCD monitor while the cassette holder is still open may cause damage to the LCD monitor.
  - Make sure the erase protection tab is in the position that allows recording. If not, slide the tab. Some cassettes have removable tabs. If the tab has been removed, cover the hole with adhesive tape.
  - The cassette holder cannot be opened while the camcorder is in record mode or detached from power source.

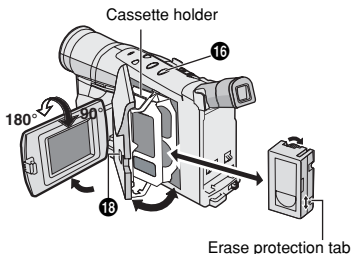

## RECORDING

Set **REC MODE**, **TAPE LENGTH** and **DATE/TIME**. (⇨ pg. 12 – 15, "MENU SETTINGS")

- 1) Remove the lens cap. Set the Power Switch **12** to "A" or "M" while pressing down the Lock Button **11**.

**Shooting while using the viewfinder:** Make sure the LCD monitor is closed and locked.

**Shooting while using the LCD monitor:** Make sure the LCD monitor is fully open.

The camcorder is in Record-Standby mode and "PAUSE" **69** is displayed.

- The viewfinder and LCD monitor cannot be used simultaneously. Therefore, when opening the LCD monitor and tilting it upward to 180°, you cannot view any image in the viewfinder. However, you can shoot yourself while viewing your own image on the LCD monitor.
- 2) Press the Recording Start/Stop Button **10**. REC **27** appears while recording is in progress.
- To stop recording, press the Recording Start/Stop Button **10**. The camcorder re-enters Record-Standby mode.

**To Adjust The Brightness Of The LCD Monitor:**

When the Power Switch **12** is set to "M", adjust "LCD BRIGHT" in SYSTEM MENU (⇨ pg. 14).

## PLAYBACK

- 1) Load a tape (⇨ "Loading/Unloading A Cassette").
- 2) Set the Power Switch **12** to "PLAY" while pressing down the Lock Button **11**. To start playback, press ▶/II **15**. To stop playback temporarily (Still Playback), press ▶/II **15**. To stop playback, press ■ **16**. Press ◀◀ **17** to rewind, or ▶▶ **14** to fast-forward. High-speed picture search (Shuttle Search) is possible by pressing ◀◀ **17** or ▶▶ **14** during playback. During playback, holding ◀◀ **17** or ▶▶ **14** down continues the search as long as you hold the button.

**For VIDEO RECORDING/VIDEO PLAYBACK**

- The camcorder shuts off automatically after about 5 minutes in the Record-Standby or Stop mode.



To turn on again, set the Power Switch **12** to "OFF", then to **[A]**, **[M]** or "PLAY".

- When the Power Switch **12** is set to **[A]**, **[M]** or "PLAY", and the LCD monitor is opened at an angle of 60 degrees or more, the LCD monitor switches on and the viewfinder switches off automatically to save power.
- The playback picture can be viewed in the viewfinder (with the LCD monitor shut), on the LCD monitor or on a connected TV (⇨ pg. 11, "Connections To A TV/VCR").
- To control the speaker volume **46**, rotate the MENU Wheel **1** towards "+" to turn up, or towards "-" to turn down. While shooting, sound is not heard from the speaker.
- Noise bars appear and pictures may become monochrome or darken during Shuttle Search. This is normal.

## BASIC FEATURES



### 5Sec. Rec (5-sec. Recording)

To record a scene for 5 seconds, providing quick scene transitions like those seen on TV.

- 1) Make sure the recording mode is set to "SP".
  - 2) During Record-Standby, press 5SEC. REC **2**.  5S **36** appears and 5Sec. Rec is reserved.
  - 3) Press the Recording Start/Stop Buttons **10**. Recording starts, and after 5 seconds, the camcorder re-enters Record-Standby mode automatically.
  - 4) To cancel the 5Sec. Rec. function, press 5SEC. REC **2** again so that  5S **36** disappears.
- Fade/Wipe (⇨ pg. 13) cannot be activated during 5Sec. Rec.



### Backlight Compensation



To increase the brightness of the subject relative to the background.

- 1) Press BACKLIGHT **15** during recording.  **24** is displayed and the subject is brightened.
  - 2) To cancel Backlight Compensation, press BACKLIGHT **15** again.  **24** disappears.
- Backlight Compensation functions in both recording modes (**[A]** or **[M]**).
  - Using BACKLIGHT **15** may brighten the subject, resulting in a washed out or white image.
  - BACKLIGHT **15** and Manual Exposure mode (⇨ pg. 13) cannot be used simultaneously.

### Auto/Manual Focus





If correct focus cannot be obtained with Auto Focus, use Manual Focus.

- 1) Set the Power Switch **12** to **[M]** while pressing down the Lock Button **11**.
- 2) Press **[M]** FOCUS **4**.  **36** appears.
- 3) To focus on a distant subject, rotate the MENU Wheel **1** upward.  appears and blinks. To focus on a close subject, rotate the MENU Wheel **1** downward.  appears and blinks.

- 4) To cancel the Manual Focus, press **[M]** FOCUS **4**.  **36** disappears and Auto Focus is applied.
- When the focus level cannot be adjusted any farther or closer,  or  will blink.

### Zooming

To produce the zoom in/out effect. Digital circuitry extends the maximum magnification offered by optical zoom. This system is called Digital Zoom.

- Slide the Power Zoom Lever **3** towards "T" to zoom in, or "W" to zoom out.
- The further you slide the Power Zoom Lever **3**, the quicker the zoom action.
- Focusing may become unstable during Zooming. In this case, set the zoom while in Record-Standby, lock the focus by using the manual focus, then zoom in or out in Record mode.
- The zoom level indicator - moves during zoom. Once the zoom level indicator - reaches the top, all magnification from that point is through digital processing.
- When using Digital Zoom, the quality of image may suffer. To deactivate Digital Zoom, set "D.ZOOM" (⇨ pg. 14) to "OFF" in CAMERA MENU.

### Quick Review

To check the end of the last recording.

- 1) Make sure the camcorder is in Record-Standby mode.
  - 2) Press **[C]** **17** and release quickly. Tape is rewound for approx. 1 second and played back automatically, then pauses in Record-Standby mode for the next shot.
- Distortion may occur at the start of playback. This is normal.

### Retake

To re-record certain segments.

- 1) Make sure the camcorder is in Record-Standby mode.
  - 2) Press and hold either RETAKE **14** or **14** to reach the start point for new recording.
  - 3) Press the Recording Start/Stop Button **10** to start recording.
- Noise bars appear and pictures may become monochrome or darken during Retake. This is normal.

## Tracking

Eliminates noise bars that appear on-screen during playback. To activate Manual Tracking:

- 1) Press the TRACKING Wheel **1** for approx. 2 seconds. "MT" **45** appears.
- 2) Rotate the TRACKING Wheel **1** so that the noise bars disappear.
  - To return to Auto Tracking, press the TRACKING Wheel **1** for approx. 2 seconds or set the Power Switch **12** to "OFF" and then "PLAY" again. "AT" **45** blinks. When Auto Tracking finishes, the indication disappears.
  - When noise bars appear during playback, the camcorder enters the Auto Tracking mode and "AT" **45** appears.
  - Manual Tracking may not work with tapes recorded on other VCRs or camcorders.

## TBC (Time Base Corrector)

Removes jitter from fluctuating video signals to deliver a stable picture even with old tapes.

To activate/release the TBC mode, press TBC **4** during playback for more than 1 second. "TBC" **41** is displayed.

- The "TBC" indicator **41** turns green (grey with a camcorder equipped with a black/white viewfinder) while TBC is working, and white while TBC is not operative.
- TBC does not work during Still Playback and Shuttle Search (see pg. 9).
- It may take a few seconds before TBC actually starts working.
- The picture may be distorted if the TBC mode is activated or deactivated at the edit-in/-out points or when normal playback resumes after Still Playback or Shuttle Search (see pg. 9).
- If the playback picture is distorted when TBC is set to on, turn off TBC.

## Connections To A TV/VCR

- 1) Make sure all units are turned off.
- 2) Connect the camcorder to a TV or VCR. If using both TV and VCR, connect the VCR output to the TV input.
- 3) Turn on all units. Set the VCR to its AUX input mode, and set the TV to its VIDEO mode.
  - Use the AC Adapter as the power supply.
  - Be sure to lower the TV volume to its minimum to avoid a sudden burst of sound when the camcorder is turned on.
  - If you have a TV or speakers that are not specially shielded, do not place the speakers adjacent to the TV as interference will occur in the camcorder playback picture.

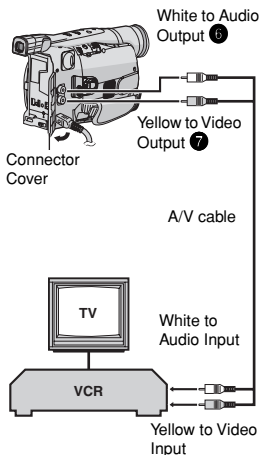

## Tape Dubbing

- 1) Connect the camcorder and the VCR (see pg. 11, "Connections To A TV/VCR"). Set the Power Switch **12** to "PLAY" while pressing down the Lock Button **11**, turn on the VCR's power, and insert the appropriate cassettes in the camcorder and the VCR. Engage the VCR's AUX and Record-Pause modes.
- 2) Press **▶/|| 15** to find a spot just before the edit-in point. Once it is reached, press **▶/|| 15** again.
- 3) Press **▶/|| 15** and engage the VCR's Record mode.
- 4) Engage the VCR's Record-Pause mode and press **▶/|| 15**.
  - Repeat steps 2) through 4) for additional editing, then stop the VCR and camcorder when finished.

**Using The Cassette Adapter (Optional)**

Use this to play back an VHS-C video cassette recorded with this camcorder on VHS VCR.

- Slide the latch ① to open the compartment door, then insert the cassette and close the compartment door ②.
  - If the color shown in the window ④ is green or red, turn the dial ⑤ in the direction of "UNLOADING" so that color changes to blue.
- Turn the dial ⑤ in the direction of "LOADING" all the way until it stops.
  - The color shown in the window ④ changes from blue → red → green (indicating playback is possible).
- Load the cassette adapter into the VCR and play the tape back.
  - To record on a VCR using a compact cassette and the adapter, cover the adapter's recording safety hole with Adhesive tape.
- To unload the cassette, turn the dial ⑤ in the direction of "UNLOADING" all the way until it stops.
  - The color shown in the window ④ changes from green → red → blue (indicating unloading is possible).
- Slide the latch ① to open the compartment door, then insert your finger in the hole ⑥, and push up and remove the cassette.
- Close the compartment door ②.

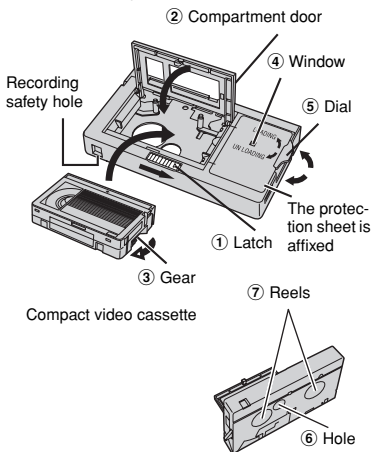

- If there is slack in the video tape when inserting the compact cassette into the adapter, the tape may become damaged. To take up slack in the tape, turn the gear ③ in the direction of the arrow.
- During tape loading and unloading, do not touch the reels ⑦ for safety and tape protection.

- During special-effect playback (slow motion, still frame, etc.), the picture may vibrate or noise bars may appear on the screen.

**MENU SETTINGS**

This Menu Screen cannot be accessed while recording.

- Set the Power Switch ⑫ to "M" while pressing down the Lock Button ⑪.
- Press the MENU Wheel ① in. The TOP MENU Screen appears. Rotate the MENU Wheel ① to select the desired menu or function and press it.

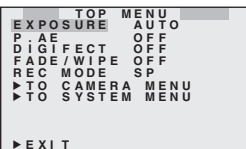

- To go from TOP MENU to CAMERA MENU, rotate the MENU Wheel ① to select "▶ TO CAMERA MENU" and press it.

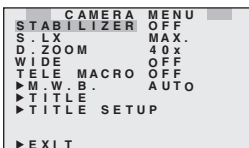

- To go from TOP MENU to SYSTEM MENU, rotate the MENU Wheel ① to select "▶ TO SYSTEM MENU" and press it. SYSTEM MENU has 2 pages. To go to the next page, rotate the MENU Wheel ① to select "▶ TO SYSTEM MENU 2" and press it.

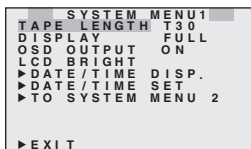

- Rotate the Menu Wheel ① to select the desired setting and press it.
- Press "▶ EXIT" to exit from any menu.

**TOP MENU****EXPOSURE**

Manual exposure adjustment is recommended in the following situations:

- When shooting using reverse lighting or when the background is too bright.
- When shooting on a reflective natural background such as at the beach or in the snow.
- When the background is overly dark or the subject light.

1) Rotate the MENU Wheel **1** to select "MANUAL", then press it.

2) To brighten the image, rotate the MENU Wheel **1** downward.

To darken the image, rotate the MENU Wheel **1** upward.

The exposure control level increases/decreases (maximum  $\pm 0.6$ ).

**P. AE (Program AE with special effects)**

**OFF:** To cancel the effect.

**SPORTS:** High shutter speed clearly captures fast-moving action.

**ND EFFECT:** A black mist darkens the picture, as when an ND filter is used. Helps to counter the effects of glare on the subject.

**FOG:** Makes the picture look misty white, as when an external fog filter is attached to the lens. Softens the image and gives it a "fantasy" look.

**TWILIGHT:** Dusk, twilight scenery, fireworks, etc., look more natural and dramatic. In this mode, the Auto Focus (⌘pg. 10) and S.LX (⌘pg. 14) may not work.

**2 1/2000 (1/2000 sec. High Speed Shutter):** Captures faster action than Sports mode. The screen becomes slightly dark. Use in well-lit environment.

**SUNSET:** Makes scenes look like a sunset with reddish tint.

**SURF&SNOW:** Compensates for subjects that may otherwise appear too dark when shooting in extremely bright surroundings such as in the snow or beach. In this mode, the fast-moving images can be recorded since the shutter speed becomes fast.

- In the "High Speed Shutter" or "Sports" modes, picture color may be adversely affected if the subject is lit by alternating discharge-type light sources such as fluorescent or mercury-vapour lights.

**DIGIFECT (Digital Effects)**

**OFF:** To cancel the effect.

**SEPIA:** Recorded scenes have a brownish tint like old photos. Combine this with WIDE in CAMERA MENU for a classic look.

**B/W: MONO :** Like black and white films, your footage is shot in B/W. Combine this with WIDE in CAMERA MENU for a classic look.

**B. FILTER:** Recorded scenes have a bluish tint.

**R. FILTER:** Recorded scenes have a reddish tint.

**SOLARI:** The picture is recorded with an effect similar to a painting.

**NEGAPOSI:** The colors of a picture are reversed.

**MOSAIC:** Turns recorded scenes into a mosaic pattern.

**STRETCH:** Doubles the width of the picture horizontally.

**FADE/WIPE**

Fade- or wipe-in works when recording begins, and fade- or wipe-out works when recording ends.

- Pressing and holding the Recording Start/Stop Button **10** allows you to vary the length for the image during fade in/out or wipe in/out.

**OFF:** To cancel the effect.

**FADER:** Fades in/out to a black screen.

**W.FADER:** Fades in/out to a white screen.

**MOSAIC (Fader):** Gradually turns/returns the picture into/from a mosaic pattern.

**SHUTTER (Wipe):** A black screen moves in from the top and bottom, closing over the image like a shutter, or a new image pushes open the black screen vertically from the center.

**SLIDE (Wipe):** A black screen moves in from the left to gradually cover the image, or a new image moves in from right to left.

**DOOR (Wipe):** Wipes in as the two halves of a black screen open to the left and right, revealing the scene, or wipes out and the black screen reappears from left and right to cover the scene.

**CORNER (Wipe):** Wipes in on a black screen from the upper right to the lower left corner, revealing the scene, or wipes out from lower left to upper right, leaving a black screen.

**WINDOW (Wipe):** Wipes in on a black screen from the center of the screen towards the corners, revealing the scene, or wipe out from the corners to the center, leaving a black screen.

**SCROLL (Wipe):** Wipes in on a black screen from the bottom to the top, revealing the scenes, or wipes out from the top to the bottom, leaving a black screen.

**REC MODE**

Allows you to set the recording mode. "EP" (Extended Play) is more economical, providing thrice the recording time.

- If the recording mode is switched, the playback picture will be blurred at the switching point.

**CAMERA MENU****— STABILIZER**

The Picture Stabilizer compensates for unstable images caused by camera-shake, particularly at high magnification.



**ON**: The Picture Stabilizer is activated.

  appears.

**OFF**: The Picture Stabilizer is deactivated.

  disappears.

- Accurate stabilization may not be possible in certain conditions including excessive hand shake.

-   appears blinking or goes out if the Stabilizer cannot be used.

**— S.LX**

**MAX**: To record a subject in a darkly lit environment, when it is more convenient to shoot the subject with a brighter image even if the picture becomes slightly coarse.

**NORMAL**: To record a subject in a dimly lit environment, when it is more convenient to shoot with a less coarse picture although the subject becomes slightly dark.

**OFF**: When you to shoot dark scenes with no picture brightness adjustment.

**— D. ZOOM**

Zooming is possible from 20X (the optical zoom limit), to a maximum of 40X or 800X digital magnification.

When set to "OFF" only optical zoom (maximum 20x magnification) can function.

**— WIDE**

When set to "ON" black bars will be recorded at the top and bottom of the screen to produce a cinema-like "wide-screen" effect.

**— TELE MACRO**

When set to "ON", you can shoot a subject as large as possible at a distance of approx. 45 cm (18"). Depending on the zoom position, the lens may go out of focus.

**— M.W.B.**



If the white balance is correct, all other colors will be accurately reproduced.

**AUTO**: White balance is adjusted automatically.

 **FINE**: Outdoors on a sunny day.

 **CLOUD**: Outdoors on a cloudy day.

 **HALOGEN**: A video light or similar type of lighting is used.

**MWB**: White balance is set manually. Hold a sheet of plain white paper in front of the subject. Adjust zoom or position yourself so that the white paper fills the screen. If it is difficult to focus on the white paper, adjust focus manually (⇐ pg. 10, "Auto/Manual Focus"). Press the MENU Wheel  in until "MWB"  begins blinking. When the setting is completed, "MWB"  stops blinking.

- Once you adjust white balance manually, the setting is retained even if the power is turned off or the battery is removed.

- White balance cannot be used when the "SEPIA" or "B/W:MONO" mode (⇐ pg. 13, "Digital Effects") is activated.

**— TITLE**

Allows you to superimpose one of eight preset titles in 4 different languages. Change the language in "LANGUAGE" in "TITLE SETUP" in CAMERA MENU.

-  shows the selected title which remains until OFF is selected.



**— TITLE SETUP**

Adjust the settings for TITLE.

**SIZE**: When "LARGE" is selected, the title is twice enlarged vertically than "NORMAL".

**SCROLL**: When "ON" is selected, the title is scrolled from right to left.

**LANGUAGE**: Select the language for TITLE.

To set "SIZE", "SCROLL" or "LANGUAGE", rotate the MENU Wheel  to select the desired item and press it. When the setting begins blinking, rotate the MENU Wheel  until the correct setting appears and then select it. The setting stops blinking.







**SYSTEM MENU****SYSTEM MENU 1****— TAPE LENGTH**

Allows you to set the tape length depending on the tape used: T20=20 minutes, T30=30 minutes, T35=35 minutes, T40=40 minutes.

- Tape remaining time  is correct only if the correct tape length has been selected.

**— DISPLAY**

**FULL**: Makes all of the indications appear on the LCD monitor/viewfinder during playback or recording.

**SIMPLE**: Makes the following indications disappear from the LCD monitor/viewfinder during recording or playback:      .

**— OSD OUTPUT**

**ON**: On-screen indications are displayed to TV etc.

**OFF**: On-screen indications are turned off except Date/Time, Instant Title and Warning Indication.

**— LCD BRIGHT**

To adjust the brightness of the LCD monitor, perform the following steps quickly (within approx. 1 second by each interval):

- Select "LCD BRIGHT" in SYSTEM MENU. The "BRIGHT ON" message appears.
- Press the BRIGHT Wheel  in to return to normal screen.

- 3) Rotate the BRIGHT Wheel **1** to display the bright level indicator **35**.
- 4) Rotate the BRIGHT Wheel **1** until the appropriate brightness is reached. After the BRIGHT Wheel **1** is released, the indicator soon disappears and adjustment is completed.

#### DATE/TIME DISP.

The date/time appears in the camcorder or on a connected monitor (set DATE/TIME in SYSTEM MENU first  $\Rightarrow$  pg. 8).

- The selected display will be recorded. If you do not want to record the display, select "OFF" before shooting.
- In the AUTO DATE mode, the camcorder records the date for about 5 seconds when recording is initiated after the date is changed, a cassette is loaded, or AUTO DATE is selected. The date is replaced after 5 seconds with "AUTO DATE" but this is not recorded.

#### DATE/TIME SET

Allows you to set the current date and time. ( $\Rightarrow$  pg. 8)

## SYSTEM MENU 2

#### DEMO MODE

Demonstrates certain functions automatically.

Available when the Power Switch **12** is set to "A" or "M" and "DEMO MODE" is set to "ON" (factory-preset).

- To cancel demonstration, set "DEMO MODE" to "OFF".
- Pressing MENU Wheel **1** directly accesses DEMO MODE menu while the demo is in progress.
- Performing any operation during the demonstration stops the demonstration temporarily. If no operation is performed for more than 1 minute after that, the demonstration will resume.
- "DEMO MODE" remains "ON" even if the camcorder power is turned off.
- When a cassette is in the camcorder, demonstration is not available.
- If you do not detach the Lens Cap, you cannot see the actual changes of the Automatic Demonstration activated on the LCD monitor or viewfinder.

#### REC TIME

You can shoot a series of pictures, each slightly different, of the same object for a brief selected period of time (Animation). REC MODE should be set to "SP".

Select the desired recording time and press the Recording Start/Stop Button **10** after focusing on the subject.

- Fade- or wipe-in/out cannot be performed.

- This function is cancelled when the power is turned off or when the cassette is ejected.
- To use this function, it is recommended that SCROLL in TITLE SETUP ( $\Rightarrow$  pg. 14) be set to "OFF".

#### INT. TIME

You can record sequentially at preset time spans. Leaving the camcorder aimed at a specific subject, you can record subtle changes over an extended period of time (Time-Lapse). REC MODE should be set to "SP".

(Please note that it is necessary to set the REC TIME (Animation) in the SYSTEM MENU before performing the INT. TIME (Time-Lapse) function.) Select the desired interval time and press the Recording Start/Stop Button **10**.

- Fade- or wipe-in/out cannot be performed.
- This function is cancelled when the power is turned off or when the cassette is ejected.
- To use this function, it is recommended that SCROLL in TITLE SETUP ( $\Rightarrow$  pg. 14) be set to "OFF".

## VCR MENU

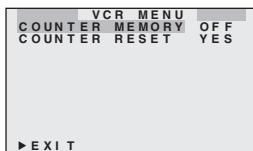

#### COUNTER MEMORY

Makes it easier to locate a specific tape segment.

- 1) Set the Power Switch **12** to "PLAY" while pressing down the Lock Button **11**.
  - 2) Press the MENU Wheel **1** in. The VCR MENU screen appears.
  - 3) Rotate the MENU Wheel **1** to select "COUNTER MEMORY" and press it. Then, rotate the MENU Wheel **1** to "ON" and press it. ("M" appears when you return to normal screen.)
  - 4) Rotate the MENU wheel to select "COUNTER RESET" and press it. Then, rotate the MENU Wheel **1** to "YES" and press it. The counter resets to "0:00:00".
  - 5) To return to normal screen, rotate the MENU Wheel **1** to "▶EXIT" and press it.
  - 6) After recording or playback, press **16**, then **17** with Power Switch **12** set to "PLAY". The tape automatically stops at or close to 0:00:00.
  - 7) Press **15** to start playback.
- The counter memory functions in both Fast-Forward and Rewind modes.

## TROUBLESHOOTING

Before consulting your JVC dealer, please check the following to see if you can correct the problem yourself.

### **Vertical white lines appear when shooting a very bright object.**

- This sometimes occurs when the contrast between the background and the object is great. It is not a defect of the camcorder.

### **Bright, crystal-shaped spots appear in the LCD monitor and the viewfinder.**

- Sunlight is directly entering the lens. This is not a defect of the camcorder.

### **colored bright spots appear all over the LCD monitor or the viewfinder.**

- The LCD monitor and the viewfinder are made with high-precision technology. However, black spots or bright spots of light (red, green or blue) may appear constantly on the LCD monitor or in the viewfinder. These spots are not recorded on the tape. This is not due to any defect of the unit. (Effective dots: more than 99.99%.)

### **Animation or Time-Lapse is not available.**

- Before recording in the Animation mode at the very beginning of a tape, set the camcorder to the Recording mode for about 5 seconds, so that the tape runs smoothly. Using the Fade-in function at this point is a good way to begin an animated program (➡ pg. 15, REC TIME/INT. TIME in SYSTEM MENU).

### **The tape is running, but there is no playback picture.**

- The TV has not been set to its VIDEO mode or channel.
- If A/V connection is used, the TV's VIDEO/TV Switch has not been set to VIDEO.

### **Playback picture is blurred or interrupted.**

- The video heads are dirty or worn out. Consult your nearest JVC dealer for head cleaning or replacement.

### **The tape stops during fast-forwarding or rewinding.**

- The Counter Memory Function has been activated (➡ pg. 15, "COUNTER MEMORY").

### **The date and time displays disappear.**

- If you remove the power source from the camcorder while the power is on, all settings and selections are erased. Make sure to turn the camcorder's power off before disconnecting the power source.





### **The tape will not eject.**

- The battery pack is running low.
- If the LCD monitor is not open over 60 degrees, the EJECT button  does not function.

The camcorder is a microcomputer-controlled device.

External noise and interference (from a TV, a radio, etc.) might prevent it from functioning properly. In such cases, first disconnect its power supply unit (battery pack, AC Adapter, etc.); and then reconnect it and proceed as usual from the beginning.

### **WARNING INDICATIONS:**

 (high) →  →  (exhausted) : Displays the battery remaining power level. As the battery power comes close to nil, the battery indicator  blinks (battery power warning). When the battery power is exhausted, power turns off automatically.

 : Blinks when no cassette is loaded, or when the erase protection tab is not in the position that allows recording.

**TAPE END:** Appears when the tape ends during recording, playback or fast-forwarding.

**LENS CAP:** Appears for 5 seconds after power is turned on if the lens cap is attached.

 **CONDENSATION OPERATION PAUSED PLEASE WAIT:** These 2 warnings appear alternately every 3 seconds if condensation occurs. In this case, all functions except tape eject and power on/off are disabled. Remove the tape, turn the unit off (without removing the power supply), wait a few minutes for the warnings to clear, and turn it on again.

 **HEAD CLEANING REQUIRED USE CLEANING CASSETTE:** These 2 warnings appear alternately every 3 seconds if dirt is detected on the heads during recording. In this case, use an optional cleaning cassette. If the warning remains after cleaning, consult your nearest JVC dealer.

**E01—E06 UNIT IN SAFEGUARD MODE REMOVE AND REATTACH BATTERY:** The error indications (E01—E06) show what type of malfunction has occurred. If an error indication and warning appear, turn the unit off, remove the power supply (battery, etc.) and wait a few minutes for them to clear. When it does, you can resume using the camcorder. If the indication remains, consult your nearest JVC dealer.



## CAUTIONS

### When using the AC Adapter in areas other than the USA

The provided AC Adapter features automatic voltage selection in the AC range from 110 V to 240 V.

### USING HOUSEHOLD AC PLUG ADAPTER

In case of connecting the unit's AC Adapter to an AC wall outlet other than American National Standard C73 series type use an AC plug adapter, called a "Siemens Plug", as shown.

For this AC plug adapter, consult your nearest JVC dealer.



- If there is dust or dirt on the AC Adapter, wipe it clean before using.

### General Battery Precautions

Please make note of the following rules for battery use. When misused, the batteries can leak or explode.

- 1) **Do not** use any different size of batteries from those specified.
- 2) Be sure to insert batteries in the correct direction.
- 3) **Do not** use Generic non-JVC batteries. Using generic non-JVC batteries can cause serious damage to the camera's internal battery charging circuits.
- 4) **Do not** expose the batteries to excessive heat as they can leak or explode.
- 5) **Do not** dispose of the batteries in a fire.
- 6) Remove the batteries from the unit if it is to be stored for an extended period to avoid battery leakage which can cause malfunctions.

### Battery Packs

The battery packs are nickel-cadmium or nickel metal-hydrate batteries. Before using the supplied battery pack or an optional battery pack, be sure to read the following cautions:

#### 1) To avoid hazard...

- ... **do not** burn.
- ... **do not** short-circuit the terminals.
- ... **do not** modify or disassemble.
- ... use only specified chargers.

#### 2) To prevent damage and prolong service life...

- ... **do not** subject to unnecessary shock.
- ... avoid repeated charging without fully discharging.
- ... charge in an environment where temperatures are within the tolerances shown in the chart below. This is a chemical reaction type battery—cooler temperatures impede chemical reaction, while warmer temperatures can prevent complete charging.
- ... store in a cool, dry place. Extended exposure to high temperatures will increase natural discharge and shorten service life.
- ... fully charged and then fully discharged the battery every 6 months when storing it over a long period of time.
- ... remove from charger or powered unit when not in use.

- It is normal for the battery pack to be warm after charging, or after use.

#### Temperature Range Specifications

Charging.....	10°C to 35°C (50°F to 95°F)
Operation .....	0°C to 40°C (32°F to 104°F)
Storage.....	-10°C to 30°C (14°F to 86°F)

- Recharging time is based on room temperature of 20°C (68°F).
- The lower the temperature, the longer recharging takes.

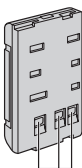

Terminals

### Cassettes

To properly use and store your cassettes:

#### 1) During use...

... beware that recording onto prerecorded tapes automatically erases the previously recorded video and audio signals.

... make sure the cassette is positioned properly when inserting.

... do not load and unload the cassette repeatedly without allowing the tape to run at all. This slackens the tape and can result in damage.

... do not open the front tape cover. This exposes the tape to fingerprints and dust.

#### 2) Store cassettes...

... away from heaters, other heat sources or direct sunlight.

... where they won't be subject to unnecessary shock or vibration.

... where they won't be exposed to strong magnetic fields (such as those generated by motors, transformers or magnets).

... vertically, in their original cases.

### Main Unit

#### 1) For safety, DO NOT...

... open the camcorder's chassis.

... disassemble or modify the unit.

... short-circuit the terminals of the battery pack. Keep it away from metallic objects when not in use.

... allow inflammables, water or metallic objects to enter the unit.

... remove the battery pack or disconnect the power supply while the power is on.

... leave the battery pack attached when the camcorder is not in use.

#### 2) Avoid using the unit...

... in places subject to excessive humidity, dust, shock or vibration.

... in places subject to soot or steam such as near a cooking stove.

... near a television set.

... near appliances generating strong magnetic or electric fields (speakers, broadcasting antennas, etc.).

... in places subject to extremely high (over 40°C or 104°F) or extremely low (under 0°C or 32°F) temperatures.

#### 3) DO NOT leave the unit...

... in places of over 50°C (122°F).

... in places where humidity is extremely low (below 35%) or extremely high (above 80%).

... in direct sunlight.

... in a closed car in summer.

... near a heater.

... in dusty places such as a beach.

#### 4) To protect the unit, DO NOT...

... allow it to become wet.

... drop the unit or strike it against hard objects.

... subject it to shock or excessive vibration during transportation.

... keep the lens directed at extremely bright objects for long periods.

... direct the eyepiece of the viewfinder at the sun.

... carry it by holding the viewfinder or the LCD monitor. Be sure to hold the main unit with both hands or use the grip.

... swing it excessively when using the shoulder strap.

**LCD Monitor****1) To prevent damage to the LCD monitor, DO NOT...**

... push it strongly or apply any shocks.  
 ... place the camcorder with the LCD monitor on the bottom.

**2) To prolong service life...**

... avoid rubbing it with coarse cloth.

**3) Beware of the following phenomena for LCD monitor use. These are not malfunctions:**

- While using the camcorder, the surface around the LCD monitor and/or the back of the LCD monitor may heat up.
- If you leave power on for a long time, the surface around the LCD monitor becomes hot.

**For Your Maintenance****1) After Use**

- ① Turn off the camcorder.
- ② Open the LCD monitor to an angle of over 60 degrees.  
Press EJECT for approximately 2 seconds to open the cassette holder, then remove the cassette.
- ③ Close and lock the cassette holder by pressing the Close button.
- ④ Close and lock the LCD monitor.
- ⑤ Slide BATTERY RELEASE to remove the battery pack.
- ⑥ Attach the provided lens cap to the camcorder's lens.

**2) Cleaning The Camcorder**

- ① Gently wipe the exterior with a soft cloth, with diluted mild soap, wipe off heavy dirt, then wipe again with a dry cloth.
- ② Wipe the LCD monitor gently with a soft cloth. Be careful not to damage the monitor. Close the LCD monitor.

**About moisture condensation...**

- You may have observed that pouring a cold liquid into a glass will cause drops of water to form on the glass outer surface. This same phenomenon occurs on the head drum of a camcorder when it is moved from a cool place to a warm place, after heating a cold room, under extremely humid conditions or in a place directly subjected to the cool air from an air conditioner.
- Moisture on the head drum can cause severe damage to the video tape, and can lead to internal damage to the camcorder itself.

**Serious malfunctioning**

If malfunctioning occurs, stop using the unit immediately and consult your local JVC dealer.

③ Blow the lens with a blower brush, then wipe it gently with lens cleaning paper.

④ Remove dust from the viewfinder using a blower brush.

- Avoid using strong cleaning agents such as benzene or alcohol.
- Cleaning should be done only after the battery pack has been removed or other power units have been disconnected.
- Mold may form if the lens is left dirty.
- When using a cleaner or chemically treated cloth, refer to the cautions that came with it.

This device complies with Part 15 of FCC Rules. Operation is subject to the following two conditions:

(1) This device may not cause harmful interference, and (2) this device must accept any interference received, including interference that may cause undesired operation.

Changes or modifications not approved by JVC could void the user's authority to operate the equipment. This equipment has been tested and found to comply with the limits for a Class B digital device, pursuant to Part 15 of the FCC Rules. These limits are designed to provide reasonable protection against harmful interference in a residential installation. This equipment generates, uses, and can radiate radio frequency energy and, if not installed and used in accordance with the instructions, may cause harmful interference to radio communications. However, there is no guarantee that interference will not occur in a particular installation. If this equipment does cause harmful interference to radio or television reception, which can be determined by turning the equipment off and on, the user is encouraged to try to correct the interference by one or more of the following measures:

Reorient or relocate the receiving antenna.

Increase the separation between the equipment and receiver.

Connect the equipment into an outlet on a circuit different from that to which the receiver is connected.

Consult the dealer or an experienced radio/TV technician for help.

## SPECIFICATIONS

### Camcorder

#### General

<b>Format</b>	: VHS NTSC standard
<b>Power source</b>	: DC 11 V $\text{---}$ (Using AC Adapter) DC 6 V $\text{---}$ (Using battery pack)

#### Power consumption

<b>Viewfinder on</b>	: 3.5 W
<b>LCD monitor on</b>	: 4.3 W
<b>Maximum</b>	: 9.2 W (When charging a battery)

**Signal system** : NTSC-type

#### Video recording system

<b>Luminance color</b>	: FM recording : Converted sub-carrier direct recording : Conforms to VHS standard
------------------------	--

**Cassette** :  cassette

#### Tape speed

<b>SP</b>	: 33.35 mm/sec. (1-5/16 ips)
<b>EP</b>	: 11.12 mm/sec. (7/16 ips)

#### Recording time (max.)

<b>SP</b>	: 40 minutes
<b>EP</b>	: 120 minutes (with TC-40 cassette)

#### Operating temperature

: 0°C to 40°C (32°F to 104°F)

**Operating humidity** : 35% to 80%

**Storage temperature** : -20°C to 50°C (-4°F to 122°F)

**Weight** : Approx. 770 g (1.7 lbs.)

**Dimensions (W x H x D)** : 81 mm x 125 mm x 216 mm  
(3-1/4" x 4-15/16" x 8-9/16")  
(with the LCD monitor closed and with the viewfinder fully tilted downward)

<b>Pickup Lens</b>	: 1/6" format CCD : F1.8, f = 2.2 mm to 44 mm, 20:1 power zoom lens with auto iris and macro control
<b>Filter diameter</b>	: $\phi$ 30.5 mm
<b>Viewfinder</b>	: Electronic viewfinder with 0.16" black/white LCD
<b>White balance adjustment</b>	: Auto/Manual adjustment
<b>LCD monitor</b>	: 2.50" diagonally measured, LCD panel/TFT active matrix system
<b>Speaker</b>	: Monaural
<b>Connectors</b>	
<b>Video</b>	: 1 V (p-p), 75 $\Omega$ unbalanced, analog output (via Video output connector)
<b>Audio</b>	: 300 mV (rms), 1 k $\Omega$ , analog output (via Audio output connector)

### AC Adapter

#### Power requirement:

**USA and Canada** : AC120V - 60V ~

**Other Countries** : AC110V - 240V ~  
50/60Hz

**Output** : DC 11 V  $\text{---}$ , 1 A

*Specifications shown are for SP mode unless otherwise indicated. E & O.E. Design and specifications subject to change without notice.*

## ESPAÑOL — ALIMENTACIÓN

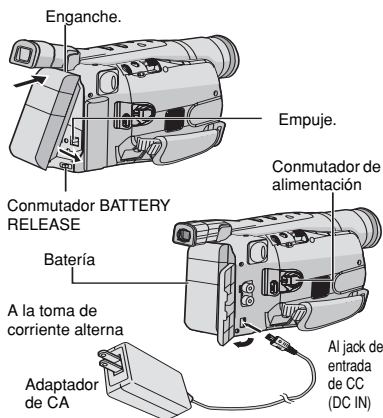

### Carga de La Batería

- 1) Asegúrese de que la batería esté colocada en la cámara de video. Enganche el extremo a la cámara de video y presione la batería hacia el interior hasta que quede bloqueada en su lugar.
  - Si la batería está colocada en la posición equivocada, puede ocurrir un fallo.
- 2) Ajuste el conmutador de alimentación **12** en "OFF" mientras presiona el botón de bloqueo **11** localizado en el conmutador. Conecte el adaptador de alimentación CA al jack de entrada de CC (DC IN) **9**.
- 3) Enchufe el adaptador de alimentación CA en una toma de corriente alterna. La lámpara indicadora CHARGE **13** de la cámara de video parpadeará para indicar que la carga se ha iniciado.
- 4) Cuando el indicador luminoso CHARGE **13** parpadea y se apaga, se ha completado la carga. Desenchufe el adaptador de alimentación CA de la toma de corriente alterna. Desconecte el adaptador de alimentación CA de la cámara de video.

### Para la extracción de la batería...

... deslice BATTERY RELEASE **8** y extraiga la batería.

Batería	Tiempo de carga
BN-V10U	approx. 1 hr. 30 min.
BN-V12U (opcional)	approx. 1 hr. 40 min.
BN-V20U (opcional)	approx. 2 hrs. 40 min.
BN-V400U (opcional)	approx. 5 hrs. 10 min.

Los tiempos de carga son para una batería completamente descargada.

### Uso de La Batería

Efectúe el paso 1) de "Carga de La Batería".

Tiempo de grabación aproximado (unidad: min)

Batería	Visor conectado	Monitor LCD conectado
BN-V10U	100	80
BN-V12U (opcional)	105	85
BN-V20U (opcional)	170	140
BN-V400U (opcional)	400	330

### Uso de La Alimentación De Ca

Conecte el adaptador de CA en la cámara de video (→ pasos 2) de "Carga de La Batería").

- El adaptador de CA suministrado presenta una selección automática de voltaje con límites de CA de 110V a 240V.

### ATENCIÓN:

Antes de retirar la fuente de alimentación, asegúrese que la alimentación de la cámara de video esté desactivada. De lo contrario puede ocurrir un fallo en la cámara de video.

### REFRESCO:

Asegúrese de descargar completamente una batería antes de recargarla, de lo contrario, el desempeño de la batería será reducido.

- 1) Ejecute los pasos de 1) hasta 3) de "Carga de La Batería".
- 2) Presione REFRESH **10** durante más de 4 segundos. La lámpara CHARGE **13** destellará para indicar que la descarga se ha iniciado.
- 3) Cuando finalice la descarga, la carga será iniciada automáticamente y la lámpara CHARGE **13** empieza a destellar.

### ALMACENAMIENTO DE LAS PILAS:

Antes de almacenar los paquetes de pilas por un largo período de tiempo, asegurarse de descargarlos completamente tomando las siguientes medidas para no reducir el rendimiento de la pilas.

- 1) Coloque la pila en la videocámara sin ningún cassette insertado.
- 2) Ajuste el conmutador de alimentación **12** en "A" o "M" mientras presiona el botón de bloqueo **11** localizado en el conmutador.

## ESPAÑOL — GUIA PARA OPERACIÓN RAPIDA

Si la unidad comienza a funcionar mal, deje de usarla inmediatamente y consulte a su concesionario local de JVC.

### Colocación/Extracción de un cassette

- 1) Abra completamente el monitor LCD y manténgalo alineado verticalmente con la cámara (no lo incline de un lado). La prensa EJECT **16** por más de 2 segundos hasta que el sostenedor de cassette se abre. No aplique fuerza para abrirlo.
  - 2) Inserte o retire un cassette. Cuando lo inserte, asegúrese de que la etiqueta esté hacia fuera.
  - 3) Presione el botón de cierre **18** para cerrar el compartimiento de cassette hasta que se trabe. Cierre el monitor LCD.
- Cerrar el monitor LCD mientras que el compartimiento de cassette todavía está abierto puede causar daños en el monitor LCD.
  - Asegúrese que la lengüeta de protección contra borrado esté en la posición que permite la grabación. De lo contrario, deslice la lengüeta. Algunos cassettes tienen lengüetas extraíbles. Si la lengüeta ha sido extraída, cubra el orificio con cinta adhesiva.
  - El compartimiento de cassette no puede ser abierto mientras la cámara de video está en el modo de grabación o desconectada de la fuente de alimentación.

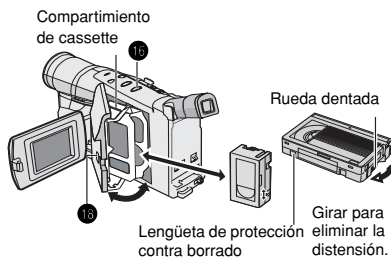

- Durante la carga o descarga, la cámara de video no puede ser operada.
- No es posible efectuar la carga o descarga si se utiliza un tipo de batería equivocado.
- Cuando efectúe la carga de la batería por primera vez o después de un largo periodo de almacenamiento, la lámpara CHARGE **13** puede no se encender. Retire la batería de la cámara de video, luego intente la carga nuevamente.
- Si el tiempo de funcionamiento de una batería completamente cargada es extremadamente corta, la batería puede estar estropeada. Adquiera una nueva batería.
- Efectúe la carga en lugares donde la temperatura sea entre 10°C y 35°C. La gama de temperatura ideal para efectuar la carga es de 20°C a 25°C. Si el ambiente es muy frío, la carga puede resultar incompleta.
- El tiempo de carga varía de acuerdo con la temperatura ambiente y el estado de la batería.
- Ya que el adaptador de CA procesa electricidad internamente, el mismo se calentará durante el uso. Asegúrese de utilizarlo sólo en áreas bien ventiladas.
- La siguiente operación interrumpirá la carga o la descarga:
  - Ajuste el interruptor de alimentación **12** en "PLAY", "A" o "M".
  - Desconecte el adaptador de CA de la cámara de video.
  - Desenchufe el adaptador de CA del tomacorriente de CA.
- Utilizando el adaptador de alimentación/cargador de CA AA-V15, es posible cargar la batería BN-V10U/V12U/V20U/V400U sin la cámara de video. Sin embargo, no es posible utilizarlo como un adaptador de CA.
- Para evitar interferencias en la recepción, no utilice el adaptador de CA cerca de una radio.
- El tiempo de grabación es significativamente reducido cuando el modo de zoom o el modo de espera de grabación es activado repetidamente o el monitor LCD es utilizado repetidamente.
- Antes del uso prolongado, se recomienda que prepare suficiente batería para cubrir 3 veces el tiempo de filmación planeado.

## GRABACIÓN

1) Retire el cubreobjetivo. Ajuste el conmutador de alimentación 12 en "A" o "M" mientras presiona el botón de bloqueo 11 localizado en el conmutador.

**Filmación utilizando el visor:** Asegúrese que el monitor LCD esté cerrado y bloqueado.

**Filmación utilizando el monitor LCD:** Asegúrese que el monitor LCD esté completamente abierto.

La cámara de video ingresa al modo de Espera de grabación y PAUSE 39 es mostrado.

- El visor y el monitor LCD no pueden ser utilizados simultáneamente en esta videocámara. Por lo tanto, cuando abra el monitor LCD y lo incline hacia arriba hasta 180°, no será posible visualizar ninguna imagen en el visor, sin embargo, podrá filmarse a sí mismo mientras visualiza su propia imagen en el monitor LCD.

2) Presione el botón de inicio/parada de grabación 10.  aparece mientras la grabación está en progreso.

- Para interrumpir la grabación, presione el botón de inicio/parada de grabación 10. La cámara de video reingresa al modo de espera de grabación.

**Para ajustar el brillo del monitor LCD:**

Cuando el conmutador de alimentación 12 está ajustado en "M", ajuste "LCD BRIGHT" en SYSTEM MENU (→ pág. 14).

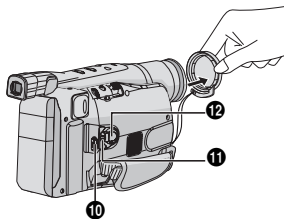

## REPRODUCCIÓN

1) Cargue una cinta.

2) Ajuste el conmutador de alimentación 12 en "PLAY" mientras presiona el botón de bloqueo 11 localizado en el conmutador. Para iniciar la reproducción, presione ▶/II 15.

Para interrumpir momentáneamente (reproducción de imágenes fijas), presione ▶/II 15.

Para interrumpir la reproducción, presione ■ 16.

Presione ◀◀ 17 para rebobinar, ▶▶ 14 para avanzar rápido la cinta.

La búsqueda de imagen a alta velocidad (Búsqueda rápida) es posible al presionar ◀◀ 17 o ▶▶ 14 durante la reproducción

(manteniendo presionado ◀◀ 17 o ▶▶ 14 durante la reproducción continuará la búsqueda hasta que sea liberado).

Durante la reproducción, el mantener presionado ◀◀ 17 o ▶▶ 14 continúa la búsqueda hasta que deje de presionar el botón.

### Para GRABACIÓN DE VIDEO/ REPRODUCCION DE VIDEO

- La cámara de video se desactiva automáticamente después de 5 minutos en el modo de espera de grabación o modo de parada. Para activarla otra vez, ajuste el conmutador de alimentación 12 en "OFF", luego en "A", "M" o "PLAY".
- Cuando el conmutador de alimentación 12 está ajustado en "A", "M" o "PLAY" y el monitor LCD está abierto en un ángulo de 60 grados o más, el monitor LCD se enciende y el visor se apaga automáticamente para ahorrar energía.
- La imagen reproducida puede ser visualizada en el visor (con el monitor LCD apagado), en el monitor LCD o en un TV conectado (→ pág. 11, "Connections To A TV/VCR").
- Para controlar el volumen de los altavoces 46, gire MENU 1 hacia "+" para aumentar o hacia "-" para disminuir. Mientras filme, el sonido no será escuchado desde los altavoces.

O simplemente reproduzca la cinta en un VCR de VHS utilizando el adaptador de cassette.

→ pág. 12

## TERMS

<b>A</b>	
AC Adapter .....	pg. 7
Animation Recording .....	pg. 15
Auto Date Record .....	pg. 15
Auto/Manual Focus .....	pg. 10
Auto Shut Off .....	pg. 9
<b>B</b>	
Backlight Compensation .....	pg. 10
Battery Pack .....	pg. 7, 17
Brighten/Darken The Image .....	pg. 13
Brighten/Darken The LCD Monitor .....	pg. 9, 14
<b>C</b>	
Cassette Adapter .....	pg. 12
Charging The Battery Pack .....	pg. 7
Clean The Camcorder .....	pg. 18
Connection To a VCR/ TV .....	pg. 11
Counter Memory .....	pg. 15
<b>D</b>	
Date/ Time Display .....	pg. 15
Date/ Time Settings .....	pg. 8
Demonstration Mode .....	pg. 1, 15
Digital Effects .....	pg. 13
Digital Zoom .....	pg. 14
Diopter Adjustment .....	pg. 8
<b>E</b>	
Erase Protection .....	pg. 9
Exposure Control .....	pg. 13
<b>F</b>	
Fade/Wipe-In/Out .....	pg. 13
Fast-Forward Tape .....	pg. 9
5-Second Recording Mode .....	pg. 10
<b>G</b>	
Grip Adjustment .....	pg. 8
<b>I</b>	
Instant Titles .....	pg. 14
<b>L</b>	
LCD Monitor/ Viewfinder, Indications .....	pg. 5, 6
Load/Unload A Tape .....	pg. 9
<b>M</b>	
Menu Screen .....	pg. 12 – 15
<b>P</b>	
Picture Stabilizer .....	pg. 14
Playback .....	pg. 9
Program AE with Special Effects .....	pg. 13
Provided Accessories .....	pg. 2
<b>Q</b>	
Quick Review .....	pg. 10
<b>R</b>	
Recording .....	pg. 9
Recording Mode .....	pg. 13
Retake .....	pg. 10
Rewind The Tape .....	pg. 9
<b>S</b>	
Shoulder Strap Attachment .....	pg. 9
Specifications .....	pg. 19
Super LoLux (S. LX) .....	pg. 14
<b>T</b>	
Tape Counter .....	pg. 15
Tape Dubbing .....	pg. 11
Tape Length Setting .....	pg. 14
Tele Macro .....	pg. 14
Time Base Corrector .....	pg. 11
Time-Lapse Shooting .....	pg. 15
Tracking .....	pg. 11
<b>V</b>	
Viewfinder Adjustment .....	pg. 8
<b>W</b>	
White Balance Adjustment .....	pg. 14
Wide Mode .....	pg. 14
<b>Z</b>	
Zooming .....	pg. 10

# JVC